

# 1

## LEFT HAND TURN

CONTESTANT #  
VEHICLE #:

- Circle each cone that is touched. Touching the base of a cone is the same as touching the side.
- Each cone only counts against the contestant once (the first time it is touched).

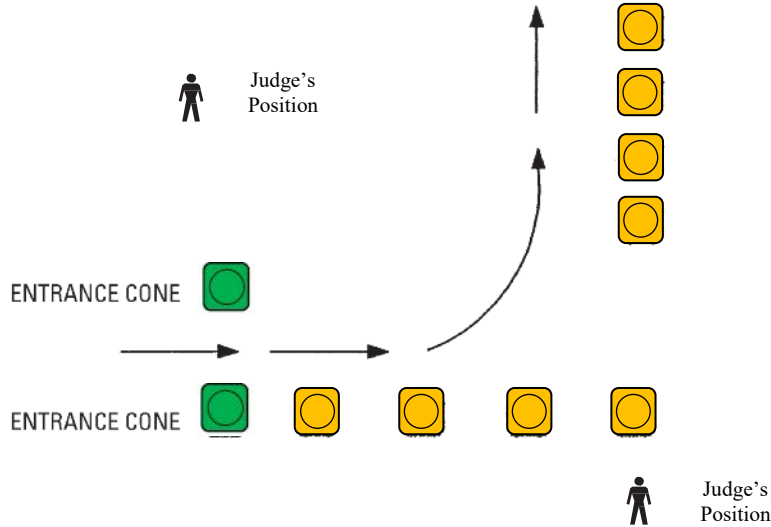

### SCORING:

|                                       | COURSE JUDGE                   | SCORE KEEPERS CALCULATIONS                                       |
|---------------------------------------|--------------------------------|--|
| Other Cones Touched                   | <input type="checkbox"/> _____ | X 10 = _____   |
| Times Shifted into Reverse            | _____                          | X 5 = _____  |
| Entrance Cones Touched                | <input type="checkbox"/> _____ | X 25 = _____   |
| Non- use of turn signal               | _____                          | X 3 = _____  |
| Did Not Complete Obstacle as Designed | <input type="checkbox"/> _____ | X 50 = _____   |
| <b>Possible Points: 50</b>            |                                | - <input type="checkbox"/> = <input type="checkbox"/>            |
|                                       | <b>Possible Points</b>         | <b>Points Deducted</b> = <b>Final Score</b><br>(Not Less Than 0) |

JUDGE'S PRINTED NAME: \_\_\_\_\_ INITIALS: \_\_\_\_\_

## Left Turn

- The two entry cones are the ones most likely to be hit. Remember, they each have a 25-point value. Watch for the right entry cone being hit by the tail swing of the vehicle.
- The use of turn signals is required on this obstacle. Three (3) points will be deducted for improper, or failure to properly use turn signals.
- The penalty assessed for each transmission shift into reverse is 5 points.
- If the driver fails to enter the obstacle through the entrance cones, or enters the obstacle out of order, or in any other way fails to complete the obstacle as designed mark it as 'did not complete obstacle as designed' on the score sheet.

## General Notes for Judges:

- Your responsibility extends from the completion of the previous exercise to the completion of the exercise you are judging.
- Make sure to record the driver # and vehicle # on every score sheet you hand in to the score runners.
- Note the location of the judges' positions marked on the score sheets. These are preferred locations for viewing the exercise, without interfering with the contestant's ability to perform the exercise.
- A cone is "hit" when any portion of the vehicle comes in contact with the cone or its base. This includes the tires, body, and bumpers. A cone does not have to be knocked over to be "hit".
- **Cones can only be 'hit' once.** If a contestant reverses and hits the same cone, they are only to be penalized for the first time they hit it (they may still lose points for unnecessary reversing!).
- Judges must reset the cones, or the curb, after they have been touched or hit. Do not reset the cones until after the vehicle clears the skills test. If a cone is being dragged, try to get the operator's and the on board judge's attention so that the vehicle can be stopped and the cone removed.
- If a dragged cone hits other cones before the vehicle is stopped, the judge must determine if the cone that was hit by the dragged cone would have been hit by the vehicle if the cone was not being dragged. Judges should use their best judgment, and be consistent.
- **The key to a fair course is that the same skill tests are the same for all operators.**
- It is permissible for the operator to stop on the course. Penalty points will not be assessed for a stop, only for transmission shifts into reverse that are not required by the skill test.
- Be careful that you do not unintentionally give the contestant's guidance through any means, including hand signals. You are not directing the contestants, you are scoring them. Keep your hand on the clipboard, or in your pockets! Similarly, spectators are not permitted to follow vehicles as they progress through the course.
- Note that different cones have different point values at the various exercises. Review the score sheets ahead of time. Sometimes it may be better for the contestant to take a five (5) point penalty for backing up than it is to hit a 25-point cone.
- If for any reason the bus must stop due to matters outside the control of the driver (obstruction on course, mechanical breakdown, or something similar) on course judges should signal this to the driver of the vehicle affected.. This may occur due to a cone left in the path of the vehicle due to a previous contestant that must be reset, or your bus may be dragging a hit cone behind it. Judges will signal a stop by holding both hands towards the driver, palms outward. Judges will signal that it is safe to resume by tapping on the side of the vehicle.

# 2

## RIGHT HAND TURN

CONTESTANT #

VEHICLE #:

- Circle each cone and rear tire marker that is touched
- Each cone only counts against the contestant once (the first time it is touched).
- Note the number of 6" segments beyond the first 6" segment the right rear tire passes by pivot cone.
- Touching the base of a cone is the same as touching the side.

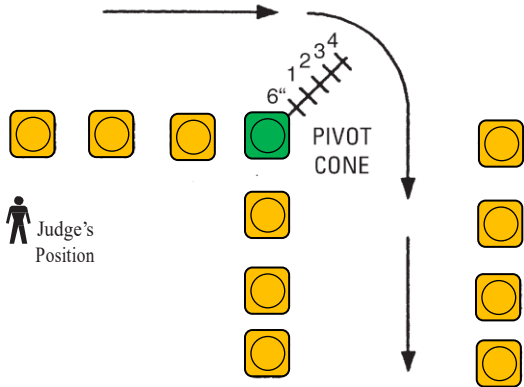

Note that to receive no point deduction, the rear curb (right) sidetire must be within six inches of the pivot cone.

On the diagram, mark the approximate location that the outside curb (right) side rear tire crosses the 45 degree line. Markings anywhere within the first 6" segment beyond the initial 6" line shall count as one, markings anywhere within the second 6" segment shall count as two, and so on.

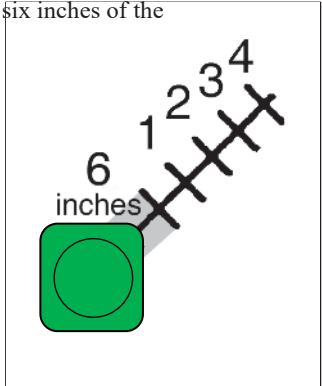

### SCORING:

### COURSE JUDGE

### SCORE KEEPERS CALCULATIONS

|   |  |   |      |   |       |
|---|--|---|------|---|-------|
| Other Cones Touched                           |  | _____   | X 10 | = | _____ |
| Number of 6" Segments Beyond First 6" Segment |  | _____   | X 5  | = | _____ |
| Times Shifted Into Reverse                    |  | _____   | X 5  | = | _____ |
| Pivot Cone Touched                            |  | <input type="checkbox"/> Yes <input type="checkbox"/> No<br>(If yes deduct) | X 25 | = | _____ |
| Non-use of turn signal                        |  | _____   | X 3  | = | _____ |
| Did Not Complete Obstacle as Designed         |  | <input type="checkbox"/>  | X 50 | = | _____ |

Possible Points: 50

Possible Points

|   |                      |   |                                  |
|---|----------------------|---|----------------------------------|
| - | <input type="text"/> | = | <input type="text"/>             |
|   | Points Deducted      |   | Final Score<br>(Not Less Than 0) |

JUDGE'S PRINTED NAME: \_\_\_\_\_ INITIALS: \_\_\_\_\_

## Right Hand Turn

- Note the location of the right, outside rear (or curbside) tire as it crosses the 45-degree line from the pivot cone. This is the point at which you must decide which interval the tire crossed. If any portion of the line marking the next 6" increment on the 45-degree line is visible as the tire crosses the 45-degree line, penalty points are deducted. The cones most likely to be hit are the driver's side entrance cone (tail swing), and the pivot cone and the exit cones.
- The use of turn signals is required on this obstacle. Three (3) points will be deducted for improper, or failure to properly use turn signals.
- The penalty assessed for each transmission shift into reverse is 5 points.
- If the driver fails to enter the obstacle through the entrance cones, or enters the obstacle out of order, or in any other way fails to complete the obstacle as designed mark it as 'did not complete obstacle as designed' on the score sheet.

## General Notes for Judges:

- Your responsibility extends from the completion of the previous exercise to the completion of the exercise you are judging.
- Make sure to record the driver # and vehicle # on every score sheet you hand in to the score runners.
- Note the location of the 'judge's position' on the score sheets. These are preferred locations for viewing the exercise, without interfering with the contestant's ability to perform the exercise.
- **A cone is "hit" when any portion of the vehicle comes in contact with the cone or its base.** This includes the tires, body, and bumpers. A cone does not have to be knocked over to be "hit".
- **Cones can only be 'hit' once.** If a contestant reverses and hits the same cone, they are only to be penalized for the first time they hit it (they may still lose points for unnecessary reversing!).
- Judges must reset the cones, or the curb, after they have been touched or hit. Do not reset the cones until after the vehicle clears the skills test. If a cone is being dragged, try to get the operator's and the on board judge's attention so that the vehicle can be stopped and the cone removed.
- If a dragged cone hits other cones before the vehicle is stopped, the judge must determine if the cone that was hit by the dragged cone would have been hit by the vehicle if the cone was not being dragged. Judges should use their best judgment, and be consistent.
- **The key to a fair course is that the same skill tests are the same for all operators.**
- It is permissible for the operator to stop on the course. Penalty points will not be assessed for a stop, only for transmission shifts into reverse that are not required by the skill test.
- Be careful that you do not unintentionally give the contestant's guidance through any means, including hand signals. You are not directing the contestants, you are scoring them. Keep your hand on the clipboard, or in your pockets! Similarly, spectators are not permitted to follow vehicles as they progress through the course.
- Note that different cones have different point values at the various exercises. Review the score sheets ahead of time. Sometimes it may be better for the contestant to take a five (5) point penalty for backing up than it is to hit a 25-point cone.
- If for any reason the bus must stop due to matters outside the control of the driver (obstruction on course, mechanical breakdown, or something similar) on course judges should signal this to the driver of the vehicle affected. This may occur due to a cone left in the path of the vehicle due to a previous contestant that must be reset, or your bus may be dragging a hit cone behind it. Judges will signal a stop by holding both hands towards the driver, palms outward. Judges will signal that it is safe to resume by tapping on the side of the vehicle.

# 3

## SERPENTINE

CONTESTANT # \_\_\_\_\_

VEHICLE #: \_\_\_\_\_

- Circle each cone that is touched. Touching the base of a cone is the same as touching the side.
- Each cone only counts against the contestant once (the first time it is touched).

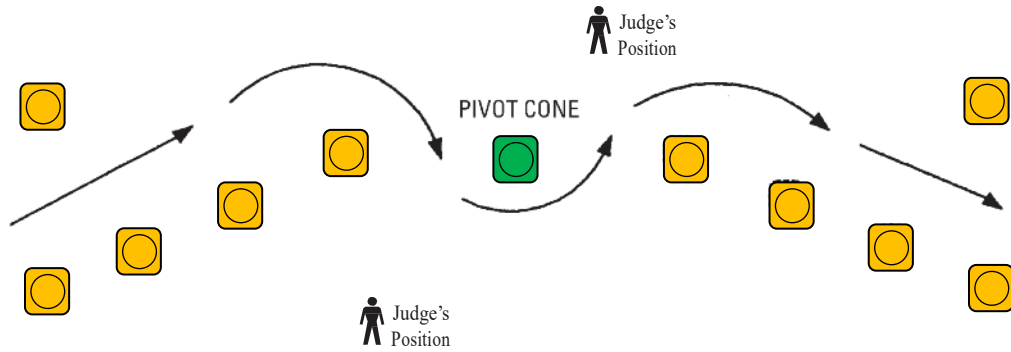

### SCORING:

### COURSE JUDGE

### SCORE KEEPERS CALCULATIONS

Pivot Cone Touched



Yes  No  
(If yes deduct)

X 25

= \_\_\_\_\_

Other Cones Touched



\_\_\_\_\_

X 10

= \_\_\_\_\_

Times Shifted Into Reverse

\_\_\_\_\_

X 5

= \_\_\_\_\_

Did Not Complete Obstacle as Designed

X 50

= \_\_\_\_\_

**Possible Points: 50**

Possible Points

-  =

=   
Final Score  
(Not Less Than 0)

JUDGE'S PRINTED NAME: \_\_\_\_\_ INITIALS: \_\_\_\_\_

## Serpentine

- The cones that are most likely to be hit are the two cones at the entrance and the pivot cone. Contestants are likely to stop and shift into reverse, so you must remember to check to see if cones are hit when the vehicle is traveling backwards. Remember, a cone can only be hit once, and additional points are not lost for hitting the same cone two or more times. **The use of turn signals is not required on this obstacle.**
- The penalty assessed for each transmission shift into reverse is 5 points.
- If the driver fails to enter the obstacle through the entrance cones, enters the obstacle out of order, fails to turn around the pivot cone in the manner required, or in any other way fails to complete the obstacle as designed mark it as 'did not complete obstacle as designed' on the score sheet.

## General Notes for Judges:

- Your responsibility extends from the completion of the previous exercise to the completion of the exercise you are judging.
- Make sure to record the driver # and vehicle # on every score sheet you hand in to the score runners.
- Note the location of the 'judge's position' on the score sheets. These are preferred locations for viewing the exercise, without interfering with the contestant's ability to perform the exercise.
- **A cone is "hit" when any portion of the vehicle comes in contact with the cone or its base.** This includes the tires, body, and bumpers. A cone does not have to be knocked over to be "hit".
- **Cones can only be 'hit' once.** If a contestant reverses and hits the same cone, they are only to be penalized for the first time they hit it (they may still lose points for unnecessary reversing!).
- Judges must reset the cones, or the curb, after they have been touched or hit. Do not reset the cones until after the vehicle clears the skills test. If a cone is being dragged, try to get the operator's and the on board judge's attention so that the vehicle can be stopped and the cone removed.
- If a dragged cone hits other cones before the vehicle is stopped, the judge must determine if the cone that was hit by the dragged cone would have been hit by the vehicle if the cone was not being dragged. Judges should use their best judgment, and be consistent.
- **The key to a fair course is that the same skill tests are the same for all operators.**
- It is permissible for the operator to stop on the course. Penalty points will not be assessed for a stop, only for transmission shifts into reverse that are not required by the skill test.
- Be careful that you do not unintentionally give the contestant's guidance through any means, including hand signals. You are not directing the contestants, you are scoring them. Keep your hand on the clipboard, or in your pockets! Similarly, spectators are not permitted to follow vehicles as they progress through the course.
- Note that different cones have different point values at the various exercises. Review the score sheets ahead of time. Sometimes it may be better for the contestant to take a five (5) point penalty for backing up than it is to hit a 25-point cone.
- If for any reason the bus must stop due to matters outside the control of the driver (obstruction on course, mechanical breakdown, or something similar) on course judges should signal this to the driver of the vehicle affected. This may occur due to a cone left in the path of the vehicle due to a previous contestant that must be reset, or your bus may be dragging a hit cone behind it. Judges will signal a stop by holding both hands towards the driver, palms outward. Judges will signal that it is safe to resume by tapping on the side of the vehicle.

# 4

## RIGHT HAND REVERSE

**CONTESTANT #**

**VEHICLE #:**

- **Circle each cone that is touched.** Touching the base of a cone is the same as touching the side.
- Each cone only counts against the contestant once (the first time it is touched).
- When vehicle stops backing up, measure distance (in inches) from the base of the rear cone to the rear bumper.

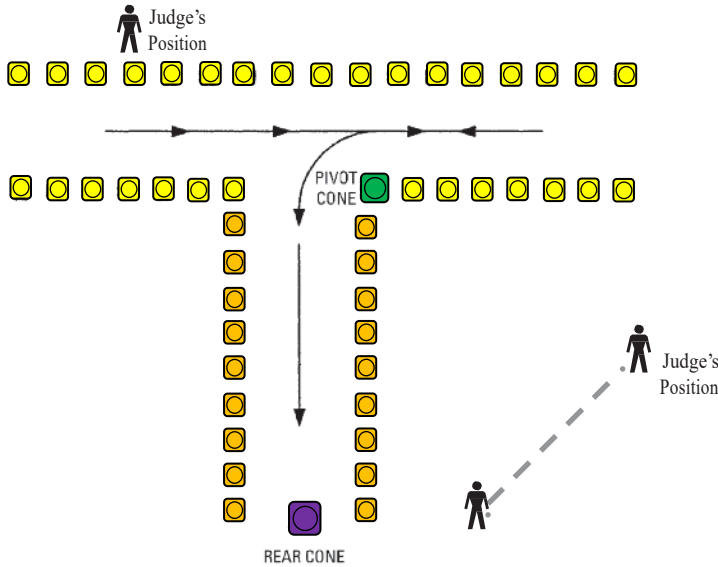

On the diagram, mark the approximate location of the bus bumper from the rear cone. Markings anywhere within the first 12" segment beyond the 36" line shall count as one, markings anywhere within the second 12" segment shall count as two, and so on.

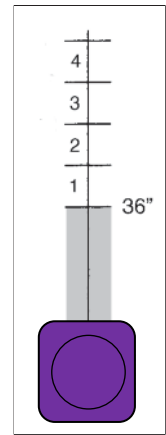

### SCORING:

|   |  |  |                          |
|---|--|--|--------------------------|
| Course Cones Touched  |  | _____  |                          |
| Rear Cone Touched   |  | <input type="checkbox"/> Yes <input type="checkbox"/> No | (If yes deduct)          |
| Lane Marker Cone Touched  |  | _____  |                          |
| Pivot Cone Touched  |  | <input type="checkbox"/> Yes <input type="checkbox"/> No | (If yes deduct)          |
| Times Shifted into Reverse<br><i>(After Initial Shift Into Reverse)</i> |  | _____  |                          |
| Number of 12" segments beyond the<br>36" limit from rear cone           |  | _____  |                          |
| Did Not Complete Obstacle as<br>Designed or did not put bus in park.    |  | <input type="checkbox"/>                                 | (If yes mark score as 0) |

### COURSE JUDGE

### SCORE KEEPERS CALCULATIONS

|                        |    |   |   |   |   |
|------------------------|----|---|---|---|---|
| X                      | 10 | = | _____   |   |   |
| -                      | 25 | = | _____   |   |   |
| X                      | 5  | = | _____   |   |   |
| -                      | 10 | = | _____   |   |   |
| X                      | 5  | = | _____   |   | (Not less than 0)                                       |
| X                      | 5  | = | _____   |   | (Not less than 0)                                       |
| <b>50</b>              | -  | = | <input style="width: 40px; height: 30px;" type="text"/> | = | <input style="width: 40px; height: 30px;" type="text"/> |
| <b>Possible Points</b> |    |   | <b>Points Deducted</b>                                  |   | <b>Final Score</b><br>(Not Less Than 0)                 |

JUDGE'S PRINTED NAME: \_\_\_\_\_ INITIALS: \_\_\_\_\_

## Right Hand Reverse

- The vehicle must come to a complete stop and be placed in park before you can determine where the rear bumper of the vehicle is with respect to the rear marker cone. **The contestant must sound the horn to signal the judges that the backing maneuver is complete and it is safe to measure the distance from the rear of the vehicle to the rear marker cone. The timekeeper must stop the clock when the horn is sounded, and start the clock when signaled to do so by the judges with a slap on the side of the vehicle.** Judges should determine the location quickly.
- Judges should note that the various marking cones have different point values. This exercise is likely to experience a cone lodged between the tires and the body. Be ready to alert the contestants to stop the vehicle if necessary. Judges must remember to watch the vehicle as it departs the exercise because points are deducted for cones hit while exiting the exercise, keeping in mind that the cone can only be hit once.
- The penalty assessed for each transmission shift (**after the first one**) into reverse is 5 points.
- **The use of turn signals is not required on this obstacle.**
- If the driver fails to enter the obstacle through the entrance cones, enters the obstacle out of order, fails to conduct the reverse into the lane in the manner required, or in any other way fails to complete the obstacle as designed mark it as 'did not complete obstacle as designed' on the score sheet.

## General Notes for Judges:

- Your responsibility extends from the completion of the previous exercise to the completion of the exercise you are judging.
- Make sure to record the driver # and vehicle # on every score sheet you hand in to the score runners.
- Note the location of the 'judge's position' on the score sheets. These are preferred locations for viewing the exercise, without interfering with the contestant's ability to perform the exercise.
- **A cone is "hit" when any portion of the vehicle comes in contact with the cone or its base.** This includes the tires, body, and bumpers. A cone does not have to be knocked over to be "hit".
- **Cones can only be 'hit' once.** If a contestant reverses and hits the same cone, they are only to be penalized for the first time they hit it (they may still lose points for unnecessary reversing!).
- Judges must reset the cones, or the curb, after they have been touched or hit. Do not reset the cones until after the vehicle clears the skills test. If a cone is being dragged, try to get the operator's and the on board judge's attention so that the vehicle can be stopped and the cone removed.
- If a dragged cone hits other cones before the vehicle is stopped, the judge must determine if the cone that was hit by the dragged cone would have been hit by the vehicle if the cone was not being dragged. Judges should use their best judgment, and be consistent.
- **The key to a fair course is that the same skill tests are the same for all operators.**
- It is permissible for the operator to stop on the course. Penalty points will not be assessed for a stop, only for transmission shifts into reverse that are not required by the skill test.
- Be careful that you do not unintentionally give the contestant's guidance through any means, including hand signals. You are not directing the contestants, you are scoring them. Keep your hand on the clipboard, or in your pockets! Similarly, spectators are not permitted to follow vehicles as they progress through the course.
- Note that different cones have different point values at the various exercises. Review the score sheets ahead of time. Sometimes it may be better for the contestant to take a five (5) point penalty for backing up than it is to hit a 25-point cone.
- If for any reason the bus must stop due to matters outside the control of the driver (obstruction on course, mechanical breakdown, or something similar) on course judges should signal this to the driver of the vehicle affected. This may occur due to a cone left in the path of the vehicle due to a previous contestant that must be reset, or your bus may be dragging a hit cone behind it. Judges will signal a stop by holding both hands towards the driver, palms outward. Judges will signal that it is safe to resume by tapping on the side of the vehicle.



# 5

## RIGHT REAR TIRE CLEARANCE

CONTESTANT # \_\_\_\_\_

VEHICLE #: \_\_\_\_\_

- Circle each ball that is touched.
- Each ball only counts against the contestant once (the first time it is touched).
- Ball does not need to move off washer to count as touched.

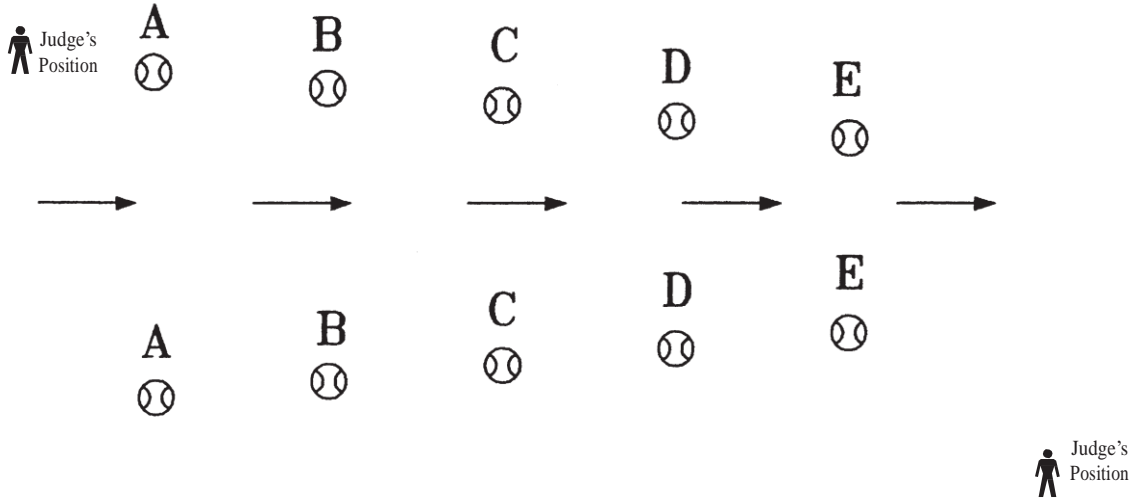

### SCORING:

|                                       |                          |
|---------------------------------------|--------------------------|
| A Balls Touched                       | _____                    |
| B Balls Touched                       | _____                    |
| C Balls Touched                       | _____                    |
| D Balls Touched                       | _____                    |
| E Balls Touched                       | _____                    |
| Did Not Complete Obstacle as Designed | <input type="checkbox"/> |

### COURSE JUDGE

### SCORE KEEPERS CALCULATIONS

|      |   |       |
|------|---|-------|
| X 20 | = | _____ |
| X 16 | = | _____ |
| X 8  | = | _____ |
| X 4  | = | _____ |
| X 2  | = | _____ |
| - 50 | = | _____ |

|                 |   |                      |   |                                  |
|-----------------|---|----------------------|---|----------------------------------|
| <b>50</b>       | - | <input type="text"/> | = | <input type="text"/>             |
| Possible Points |   | Points Deducted      |   | Final Score<br>(Not Less Than 0) |

JUDGE'S PRINTED NAME: \_\_\_\_\_ INITIALS: \_\_\_\_\_

## Right Rear Tire Clearance

- Judges may need to crouch down to see if the tennis balls are being hit. It makes no difference if the tennis balls are hit by the front or rear tires. Once a ball is hit, points are lost. As with the cones, tennis balls can be hit only once. Keep in mind that the tennis balls have varying point values. If a hit tennis ball rolls into another ball, the judges must use their judgment to determine if that ball would have been hit by the tire anyway. Again, be consistent.
- Turn signal is optional for this event.
- The penalty assessed for each transmission shift into reverse is 5 points.
- If the driver fails to enter the obstacle through the tennis balls, enters the obstacle out of order, drives between the balls using their left (or streetside) tire, or in any other way fails to complete the obstacle as designed mark it as 'did not complete obstacle as designed' on the score sheet.

## General Notes for Judges:

- Your responsibility extends from the completion of the previous exercise to the completion of the exercise you are judging.
- Make sure to record the driver # and vehicle # on every score sheet you hand in to the score runners.
- Note the location of the 'judge's position' on the score sheets. These are preferred locations for viewing the exercise, without interfering with the contestant's ability to perform the exercise.
- **A ball is "hit" when any portion of the vehicle comes in contact with the ball.** This includes the tires, body, and bumpers. A ball does not have to be knocked over to be "hit".
- **Balls can only be 'hit' once.** If a contestant reverses and hits the same ball, they are only to be penalized for the first time they hit it (they may still lose points for unnecessary reversing!).
- Judges must reset the balls, after they have been touched or hit. Do not reset the balls until after the vehicle clears the skills test. If a ball is being dragged, try to get the operator's and the on board judge's attention so that the vehicle can be stopped and the ball removed.
- If a dragged ball hits other balls before the vehicle is stopped, the judge must determine if the ball that was hit by the hit or rolling ball would have been hit by the vehicle if the ball was not being dragged. Judges should use their best judgment, and be consistent.
- **The key to a fair course is that the same skill tests are the same for all operators.**
- It is permissible for the operator to stop on the course. Penalty points will not be assessed for a stop, only for transmission shifts into reverse that are not required by the skill test.
- Be careful that you do not unintentionally give the contestant's guidance through any means, including hand signals. You are not directing the contestants, you are scoring them. Keep your hand on the clipboard, or in your pockets! Similarly, spectators are not permitted to follow vehicles as they progress through the course.
- Note that different balls have different point values at the various exercises. Review the score sheets ahead of time. Sometimes it may be better for the contestant to take a five (5) point penalty for backing up than it is to hit a 25-point ball.
- If for any reason the bus must stop due to matters outside the control of the driver (obstruction on course, mechanical breakdown, or something similar) on course judges should signal this to the driver of the vehicle affected. This may occur due to a ball left in the path of the vehicle due to a previous contestant that must be reset, or your bus may be dragging a hit cone behind it. Judges will signal a stop by holding both hands towards the driver, palms outward. Judges will signal that it is safe to resume by tapping on the side of the vehicle. The time clock should be stopped and restarted.

# 6

## PASSENGER STOP

CONTESTANT #

VEHICLE #:

- Circle each cone that is touched. Touching the base of a cone is the same as touching the side.
- Each cone only counts against the contestant once (the first time it is touched).
- If vehicle tire strikes curb, mark first contact only with an "X".
- Measure distance in inches from edge of curb to the front and rear tires.

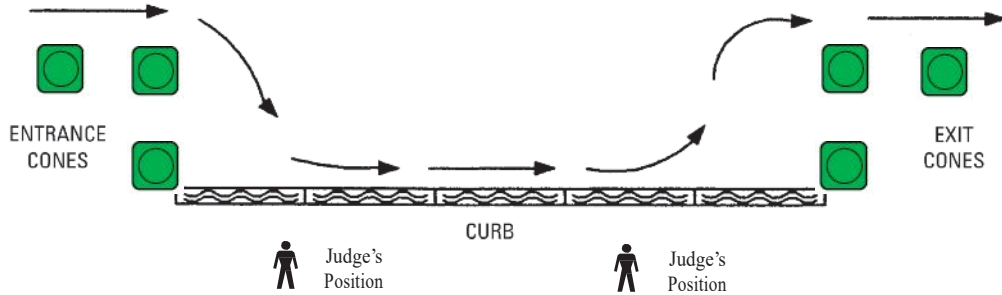

### SCORING:

Entrance/Exit Cones Touched \_\_\_\_\_

Curb Touched \_\_\_\_\_

Front Tire Distance From Curb (in inches) \_\_\_\_\_

All distance rounded up to the next inch.

A measure of 10 3/4" or 10 7/8" would be recorded as 11".

Rear Tire Distance From Curb (in inches) \_\_\_\_\_

All distance rounded up to the next inch.

A measure of 10 3/4" or 10 7/8" would be recorded as 11".

Times Shifted Into Reverse \_\_\_\_\_

Non-use of turn signal \_\_\_\_\_

Did Not Complete Obstacle as Designed  
or did not put vehicle in park for  
measurement. \_\_\_\_\_

### COURSE JUDGE

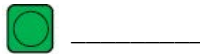

Yes  No  
(If yes deduct)

### SCORE KEEPERS CALCULATIONS

X 25 = \_\_\_\_\_

- 25 = \_\_\_\_\_

- 6" = \_\_\_\_\_ (Not Less Than 0)  
\* 1 point off per inch beyond 6"

- 15" = \_\_\_\_\_ (Not Less Than 0)  
\* 1 point off per inch beyond 15"

X 5 = \_\_\_\_\_

X 3 = \_\_\_\_\_

X 50 = \_\_\_\_\_

**50** -  =   
**Possible Points**      **Points Deducted**      **Final Score**

(Not Less Than 0)

JUDGE'S PRINTED NAME: \_\_\_\_\_ INITIALS: \_\_\_\_\_

## Passenger Stop

- Consistency in measurement is the key to this exercise. Measure the distance from the top edge of the curb, 4x4, or simulated curb to the center of the tire below the axle at the same height as the top of the curb. Be sure that the yardstick is perpendicular to the curb when you measure. Measurements are rounded up. If you measure 8 1/4" or 8 3/4", it should be recorded as 9" on the score sheet. Hitting the curb or cones at any time, either entering or departing the stop, loses points, so be careful to watch the cones and curb as the vehicle departs the exercise. **The contestant must place the vehicle in park and sound the horn to indicate to the judges that it is safe to measure the distance between the curb and the tires. The timekeeper must stop the clock when the horn is sounded, and restart the clock when signaled to do so by the judges with a slap on the side of the vehicle.**
- If the front or rear tires of the vehicle are more than 36" from the curb, use the supplied tape measurer to determine the true distance and record it, applying the same deduction, however far away the vehicle may have stopped.
- Turn signals are required when entering and exiting the passenger stop.
- The penalty assessed for each transmission shift into reverse is 5 points.
- If the driver fails to enter the obstacle through the entrance cones, enters the obstacle out of order, fails to park in the manner required, or in any other way fails to complete the obstacle as designed mark it as 'did not complete obstacle as designed' on the score sheet.

## General Notes for Judges:

- Your responsibility extends from the completion of the previous exercise to the completion of the exercise you are judging.
- Make sure to record the driver # and vehicle # on every score sheet you hand in to the score runners.
- Note the location of the 'judge's position' on the score sheets. These are preferred locations for viewing the exercise, without interfering with the contestant's ability to perform the exercise.
- **A cone is "hit" when any portion of the vehicle comes in contact with the cone or its base.** This includes the tires, body, and bumpers. A cone does not have to be knocked over to be "hit".
- **Cones can only be 'hit' once.** If a contestant reverses and hits the same cone, they are only to be penalized for the first time they hit it (they may still lose points for unnecessary reversing!).
- Judges must reset the cones, or the curb, after they have been touched or hit. Do not reset the cones until after the vehicle clears the skills test. If a cone is being dragged, try to get the operator's and the on board judge's attention so that the vehicle can be stopped and the cone removed.
- If a dragged cone hits other cones before the vehicle is stopped, the judge must determine if the cone that was hit by the dragged cone would have been hit by the vehicle if the cone was not being dragged. Judges should use their best judgment, and be consistent.
- **The key to a fair course is that the same skill tests are the same for all operators.**
- It is permissible for the operator to stop on the course. Penalty points will not be assessed for a stop, only for transmission shifts into reverse that are not required by the skill test.
- Be careful that you do not unintentionally give the contestant's guidance through any means, including hand signals. You are not directing the contestants, you are scoring them. Keep your hand on the clipboard, or in your pockets! Similarly, spectators are not permitted to follow vehicles as they progress through the course.
- Note that different cones have different point values at the various exercises. Review the score sheets ahead of time. Sometimes it may be better for the contestant to take a five (5) point penalty for backing up than it is to hit a 25-point cone.
- If for any reason the bus must stop due to matters outside the control of the driver (obstruction on course, mechanical breakdown, or something similar) on course judges should signal this to the driver of the vehicle affected. This may occur due to a cone left in the path of the vehicle due to a previous contestant that must be reset, or your bus may be dragging a hit cone behind it. Judges will signal a stop by holding both hands towards the driver, palms outward. Judges will signal that it is safe to resume by tapping on the side of the vehicle. Time clock should be stopped & restarted.

# 7

## OFFSET STREET

CONTESTANT # \_\_\_\_\_

VEHICLE #: \_\_\_\_\_

- Circle each cone that is touched. Touching the base of a cone is the same as touching the side.
- Each cone only counts against the contestant once (the first time it is touched).

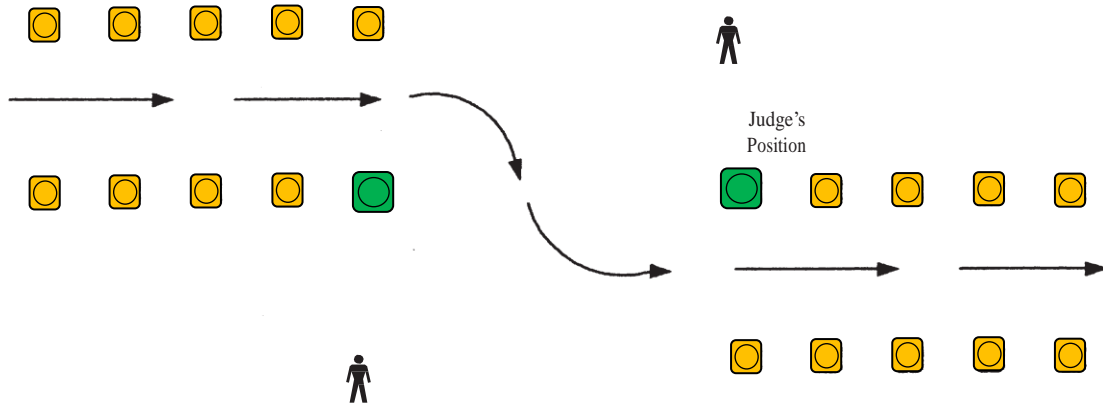

### SCORING:

Cones Touched

Times Shifted Into Reverse

Pivot Cone Touched

Did Not Complete Obstacle as Designed

### COURSE JUDGE

 \_\_\_\_\_

\_\_\_\_\_

 \_\_\_\_\_

\_\_\_\_\_

### SCORE KEEPERS CALCULATIONS

X 5 = \_\_\_\_\_

X 5 = \_\_\_\_\_

X 10 = \_\_\_\_\_

- 50 = \_\_\_\_\_

50 -  =

Possible Points      Points Deducted      Final Score

(Not Less Than 0)

JUDGE'S PRINTED NAME: \_\_\_\_\_ INITIALS: \_\_\_\_\_

## Offset Street

- Judges should be careful to watch the last cone in the entrance set on the driver's side. This cone is likely to be hit as the rear of the vehicle swings through the turn. Watch the entrance cones on the second set for bumper contact, and watch the tires of the bus as they pass by the base of the cones.
- The penalty assessed for each transmission shift into reverse is 5 points.
- **Use of turn signal not required for this obstacle.**
- If the driver fails to enter the obstacle through the entrance cones, enters the obstacle out of order, fails to drive between the cones in the manner required, or in any other way fails to complete the obstacle as designed mark it as 'did not complete obstacle as designed' on the score sheet.

## General Notes for Judges:

- Your responsibility extends from the completion of the previous exercise to the completion of the exercise you are judging.
- Make sure to record the driver # and vehicle # on every score sheet you hand in to the score runners.
- Note the location of the 'judge's position' on the score sheets. These are preferred locations for viewing the exercise, without interfering with the contestant's ability to perform the exercise.
- **A cone is "hit" when any portion of the vehicle comes in contact with the cone or its base.** This includes the tires, body, and bumpers. A cone does not have to be knocked over to be "hit".
- **Cones can only be 'hit' once.** If a contestant reverses and hits the same cone, they are only to be penalized for the first time they hit it (they may still lose points for unnecessary reversing!).
- Judges must reset the cones, or the curb, after they have been touched or hit. Do not reset the cones until after the vehicle clears the skills test. If a cone is being dragged, try to get the operator's and the on board judge's attention so that the vehicle can be stopped and the cone removed.
- If a dragged cone hits other cones before the vehicle is stopped, the judge must determine if the cone that was hit by the dragged cone would have been hit by the vehicle if the cone was not being dragged. Judges should use their best judgment, and be consistent.
- **The key to a fair course is that the same skill tests are the same for all operators.**
- It is permissible for the operator to stop on the course. Penalty points will not be assessed for a stop, only for transmission shifts into reverse that are not required by the skill test.
- Be careful that you do not unintentionally give the contestant's guidance through any means, including hand signals. You are not directing the contestants, you are scoring them. Keep your hand on the clipboard, or in your pockets! Similarly, spectators are not permitted to follow vehicles as they progress through the course.
- Note that different cones have different point values at the various exercises. Review the score sheets ahead of time. Sometimes it may be better for the contestant to take a five (5) point penalty for backing up than it is to hit a 25-point cone.
- If for any reason the bus must stop due to matters outside the control of the driver (obstruction on course, mechanical breakdown, or something similar) on course judges should signal this to the driver of the vehicle affected. This may occur due to a cone left in the path of the vehicle due to a previous contestant that must be reset, or your bus may be dragging a hit cone behind it. Judges will signal a stop by holding both hands towards the driver, palms outward. Judges will signal that it is safe to resume by tapping on the side of the vehicle. Time clock should be stopped & restarted.

# 8

## LEFT HAND REVERSE

CONTESTANT # \_\_\_\_\_

VEHICLE #: \_\_\_\_\_

- Circle each cone that is touched. Touching the base of a cone is the same as touching the side.
- Each cone only counts against the contestant once (the first time it is touched).
- When vehicle stops backing up, count the number of 12" segments beyond the 36" limit from rear cone.

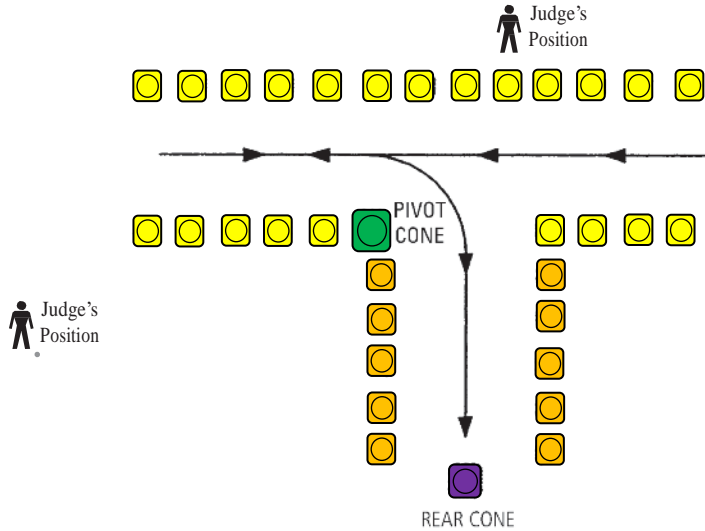

On the diagram, mark the approximate location of the bus bumper from the rear cone. Markings anywhere within the first 12" segment beyond the 36" line shall count as one, markings anywhere within the second 12" segment shall count as two, and so on.

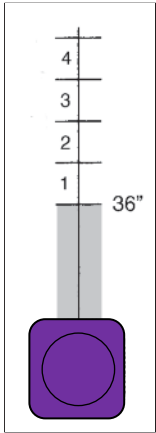

### SCORING:

Course Cones Touched \_\_\_\_\_

Lane Cones Touched \_\_\_\_\_

12" segments beyond the 36" limit from rear cone \_\_\_\_\_

Times Shifted Into Reverse  
(After Initial Shift Into Reverse) \_\_\_\_\_

Rear Cone Touched \_\_\_\_\_

Pivot Cone Touched \_\_\_\_\_

Did Not Complete Obstacle as Designed or did not put vehicle in park. \_\_\_\_\_

### COURSE JUDGE

\_\_\_\_\_

\_\_\_\_\_

\_\_\_\_\_

\_\_\_\_\_

Yes  No  
(If yes deduct)

Yes  No  
(If yes deduct)

\_\_\_\_\_

### SCORE KEEPERS CALCULATIONS

X 10 = \_\_\_\_\_

X 5 = \_\_\_\_\_

X 5 = \_\_\_\_\_

X 5 = \_\_\_\_\_

X 25 = \_\_\_\_\_

X 10 = \_\_\_\_\_

X 50 = \_\_\_\_\_

50

Possible Points

Points Deducted

=

Final Score  
(Not Less Than 0)

JUDGE'S PRINTED NAME: \_\_\_\_\_ INITIALS: \_\_\_\_\_

## Left Hand Reverse

- **The vehicle must come to a complete stop and be placed in park** before you can determine where the rear bumper of the vehicle is with respect to the rear marker cone. **The contestant must sound the horn to signal the judges that the backing maneuver is complete and it is safe to measure the distance from the rear of the vehicle to the rear marker cone. The timekeeper must stop the clock when the horn is sounded, and start the clock when signaled to do so by the judges with a slap on the side of the vehicle.** Judges should determine the location quickly. **Use of the turn signal is not required for this obstacle.**
- Judges should note that the various marking cones have different point values. This exercise is likely to experience a cone lodged between the tires and the body. Be ready to alert the contestants to stop the vehicle if necessary. Judges must remember to watch the vehicle as it departs the exercise because points are deducted for cones hit while exiting the exercise, keeping in mind that the cone can only be hit once.
- The penalty assessed for each transmission shift (**after the first one**) into reverse is 5 points.
- If the driver fails to enter the obstacle through the entrance cones, enters the obstacle out of order, fails to conduct the reverse into the lane in the manner required, or in any other way fails to complete the obstacle as designed mark it as ‘did not complete obstacle as designed’ on the score sheet.

## General Notes for Judges:

- Your responsibility extends from the completion of the previous exercise to the completion of the exercise you are judging.
- Make sure to record the driver # and vehicle # on every score sheet you hand in to the score runners.
- Note the location of the ‘judge’s position’ on the score sheets. These are preferred locations for viewing the exercise, without interfering with the contestant’s ability to perform the exercise.
- **A cone is “hit” when any portion of the vehicle comes in contact with the cone or its base.** This includes the tires, body, and bumpers. A cone does not have to be knocked over to be “hit”.
- **Cones can only be ‘hit’ once.** If a contestant reverses and hits the same cone, they are only to be penalized for the first time they hit it (they may still lose points for unnecessary reversing!).
- Judges must reset the cones, or the curb, after they have been touched or hit. Do not reset the cones until after the vehicle clears the skills test. If a cone is being dragged, try to get the operator’s and the on board judge’s attention so that the vehicle can be stopped and the cone removed.
- If a dragged cone hits other cones before the vehicle is stopped, the judge must determine if the cone that was hit by the dragged cone would have been hit by the vehicle if the cone was not being dragged. Judges should use their best judgment, and be consistent.
- **The key to a fair course is that the same skill tests are the same for all operators.**
- It is permissible for the operator to stop on the course. Penalty points will not be assessed for a stop, only for transmission shifts into reverse that are not required by the skill test.
- Be careful that you do not unintentionally give the contestant’s guidance through any means, including hand signals. You are not directing the contestants, you are scoring them. Keep your hand on the clipboard, or in your pockets! Similarly, spectators are not permitted to follow vehicles as they progress through the course.
- Note that different cones have different point values at the various exercises. Review the score sheets ahead of time. Sometimes it may be better for the contestant to take a five (5) point penalty for backing up than it is to hit a 25-point cone.
- If for any reason the bus must stop due to matters outside the control of the driver (obstruction on course, mechanical breakdown, or something similar) on course judges should signal this to the driver of the vehicle affected. This may occur due to a cone left in the path of the vehicle due to a previous contestant that must be reset, or your bus may be dragging a hit cone behind it. Judges will signal a stop by holding both hands towards the driver, palms outward. Judges will signal that it is safe to resume by tapping on the side of the vehicle. Time clock should be stopped & restarted.



# 9

## DIMINISHING CLEARANCE

CONTESTANT #

VEHICLE #:

- Circle each barrel that is touched.
- Each barrel only counts against the contestant once (the first time it is touched).
- Speed detection will determine if vehicle maintains minimum speed of 20 MPH through all ten barrels.

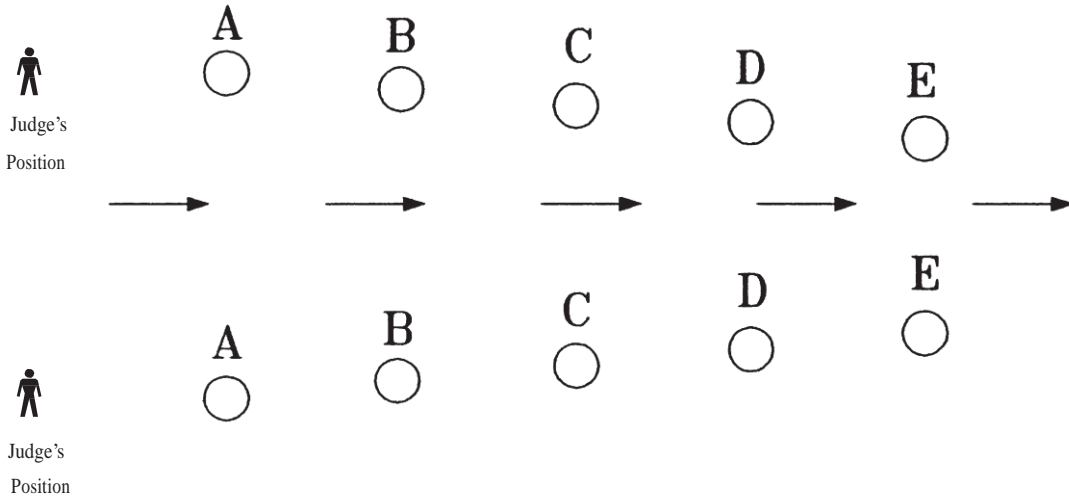

### SCORING:

Number of A Barrels Touched

Number of B Barrels Touched

Number of C Barrels Touched

Number of D Barrels Touched

Number of E Barrels Touched

Achieved Minimum Speed of 20 MPH

Did Not Complete Obstacle as Designed

### COURSE JUDGE

\_\_\_\_\_ X

\_\_\_\_\_ X

\_\_\_\_\_ X

\_\_\_\_\_ X

\_\_\_\_\_ X

Yes  No - 25  
(If yes deduct)

- 50

### SCORE KEEPERS CALCULATIONS

20 = \_\_\_\_\_

16 = \_\_\_\_\_

8 = \_\_\_\_\_

4 = \_\_\_\_\_

2 = \_\_\_\_\_

25 = \_\_\_\_\_

50 = \_\_\_\_\_

50

Possible Points

-  =   
Points Deducted

=   
Final Score  
(Not Less Than 0)

JUDGE'S PRINTED NAME: \_\_\_\_\_ INITIALS: \_\_\_\_\_

## Diminishing Clearance

- In this exercise, the vehicle must travel at least 20 MPH. The radar gun, not the vehicle speedometer, is the official measurement device, so judges must watch the signal of the radar gun operator. The vehicle must reach this speed before entering the barrels, or while in the exercise. Judges should be careful to stand away from the barrels. **Use of turn signal not required.**
- The penalty assessed for each transmission shift into reverse is 5 points.
- If the driver fails to enter the obstacle through the entrance barrels, enters the obstacle out of order, fails to drive between the barrels in the manner required, or in any other way fails to complete the obstacle as designed mark it as 'did not complete obstacle as designed' on the score sheet.

## General Notes for Judges:

- Your responsibility extends from the completion of the previous exercise to the completion of the exercise you are judging.
- Make sure to record the driver # and vehicle # on every score sheet you hand in to the score runners.
- Note the location of the 'judge's position' on the score sheets. These are preferred locations for viewing the exercise, without interfering with the contestant's ability to perform the exercise.
- **A barrel is "hit" when any portion of the vehicle comes in contact with the cone or its base.** This includes the tires, body, and bumpers. A barrel does not have to be knocked over to be "hit".
- Judges must reset the barrels, or the curb, after they have been touched or hit. Do not reset the barrels until after the vehicle clears the skills test.
- **The key to a fair course is that the same skill tests are the same for all operators.**
- It is permissible for the operator to stop on the course. Penalty points will not be assessed for a stop, only for transmission shifts into reverse that are not required by the skill test.
- Be careful that you do not unintentionally give the contestant's guidance through any means, including hand signals. You are not directing the contestants, you are scoring them. Keep your hand on the clipboard, or in your pockets! Similarly, spectators are not permitted to follow vehicles as they progress through the course.
- Note that different barrels have different point values at the various exercises. Review the score sheets ahead of time. Sometimes it may be better for the contestant to take a five (5) point penalty for backing up than it is to hit a 25-point barrel.
- If for any reason the bus must stop due to matters outside the control of the driver (obstruction on course, mechanical breakdown, or something similar) on course judges should signal this to the driver of the vehicle affected. This may occur due to a barrel left in the path of the vehicle due to a previous contestant that must be reset, or your bus may be dragging a hit barrel behind it. Judges will signal a stop by holding both hands towards the driver, palms outward. Judges will signal that it is safe to resume by tapping on the side of the vehicle.

# 10

## JUDGEMENT STOP

|              |
|--------------|
| CONTESTANT # |
| VEHICLE #:   |

- **Circle cone if contact is made.** Touching the base of a cone is the same as touching the side.
- Measure distance (in inches) from bottom of cone to vehicle bumper after vehicle has stopped.

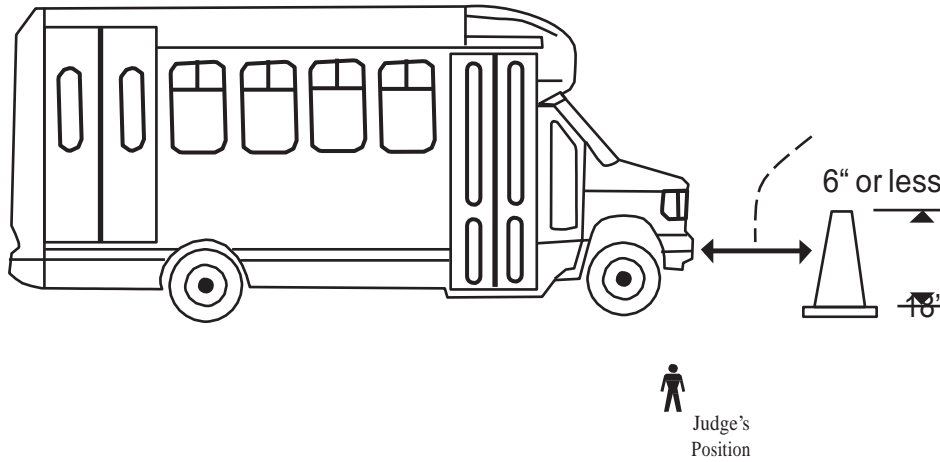

### SCORING:

### COURSE JUDGE

18" Marker Touched

\_\_\_\_\_ X

**Distance From Cone** All distance rounded up to the next inch.  
A measure of 10 1/4" or 10 3/4" would be recorded as 11".  
\* 1 point off for each 1" beyond 6"

\_\_\_\_\_ --

Additional Full Stops  
(After Initial Full Stop)

\_\_\_\_\_ X

Did Not Complete Obstacle as Designed

### SCORE KEEPERS CALCULATIONS

50 = \_\_\_\_\_

6 = \_\_\_\_\_  
(Not Less Than 0)\*

25 = \_\_\_\_\_

50 = \_\_\_\_\_

**50**  
Possible  
Points

-   
Points  
Deducted

=   
Final  
Score  
(Not Less Than 0)

JUDGE'S PRINTED NAME: \_\_\_\_\_ INITIALS: \_\_\_\_\_

## Judgment Stop

- In measuring the distance between the cone and the front bumper of the vehicle, it is very important to be consistent in your measurements. Measure the distance from the cone to the bumper by placing the yardstick on top of the cone, with the 1" increments on the yardstick starting at the end toward the vehicle. Read the distance where the yardstick crosses the outside of the cone. Measurements are rounded up. If you measure 8 1/4" or 8 3/4", it should be recorded as 9" on the score sheet.
- The vehicle should make only one full stop. Additional full stops are penalized and 25 points are deducted for each additional stop.
- If the driver enters the obstacle out of order, fails to stop at the cone in the manner required, or in any other way fails to complete the obstacle as designed mark it as 'did not complete obstacle as designed' on the score sheet.

## General Notes for Judges:

- Your responsibility extends from the completion of the previous exercise to the completion of the exercise you are judging.
- Make sure to record the driver # and vehicle # on every score sheet you hand in to the score runners.
- Note the location of the 'judge's position' on the score sheets. These are preferred locations for viewing the exercise, without interfering with the contestant's ability to perform the exercise.
- **A cone is "hit" when any portion of the vehicle comes in contact with the cone or its base.** This includes the tires, body, and bumpers. A cone does not have to be knocked over to be "hit".
- **Cones can only be 'hit' once.** If a contestant reverses and hits the same cone, they are only to be penalized for the first time they hit it (they may still lose points for unnecessary reversing!).
- Judges must reset the cones, or the curb, after they have been touched or hit. Do not reset the cones until after the vehicle clears the skills test. If a cone is being dragged, try to get the operator's and the on board judge's attention so that the vehicle can be stopped and the cone removed.
- If a dragged cone hits other cones before the vehicle is stopped, the judge must determine if the cone that was hit by the dragged cone would have been hit by the vehicle if the cone was not being dragged. Judges should use their best judgment, and be consistent.
- **The key to a fair course is that the same skill tests are the same for all operators.**
- It is permissible for the operator to stop on the course. Penalty points will not be assessed for a stop, only for transmission shifts into reverse that are not required by the skill test.
- Be careful that you do not unintentionally give the contestant's guidance through any means, including hand signals. You are not directing the contestants, you are scoring them. Keep your hand on the clipboard, or in your pockets! Similarly, spectators are not permitted to follow vehicles as they progress through the course.
- If for any reason the bus must stop due to matters outside the control of the driver (obstruction on course, mechanical breakdown, or something similar) on course judges should signal this to the driver of the vehicle affected. This may occur due to a cone left in the path of the vehicle due to a previous contestant that must be reset, or your bus may be dragging a hit cone behind it. Judges will signal a stop by holding both hands towards the driver, palms outward. Judges will signal that it is safe to resume by tapping on the side of the vehicle.



# SMOOTHNESS OF OPERATION & ELAPSED TIME

CONTESTANT #

VEHICLE #:

Evaluate each contestant on his/her ability to deliver a smooth ride and safety habits on bus. The following criteria is to be employed in making each evaluation.

COURSE JUDGE

SCORE KEEPERS CALCULATIONS

## SCORING (25 Points Possible):

### SMOOTHNESS OF OPERATION:

- Number of Sudden Starts \_\_\_\_\_ X 3 = \_\_\_\_\_
- Number of Sudden Stops \_\_\_\_\_ X 3 = \_\_\_\_\_
- Number of Abrupt Turns \_\_\_\_\_ X 3 = \_\_\_\_\_
- Non-seatbelt use \_\_\_\_\_ X 5 = \_\_\_\_\_

Total Points Deducted:

Total Points Earned:

|  |
|--|
|  |
|  |

### TIME PENALTY:

Timing begins when vehicle front bumper crosses the starting line and ends when the vehicle comes to a final full stop at the last obstacle. **Pause the stop watch when the vehicle stops for measurements at the Right Hand Reverse, Passenger Stop, Left Hand Reverse or if the vehicle is held for any reason along the course.**

Contestant's Time \_\_\_\_\_ : \_\_\_\_\_  
Minutes Seconds

A time penalty of 1 point per second will be assessed for any time over 7 minutes. This calculation will be performed by the official scorekeepers.

To be completed by official scorekeepers: Time over 7 min. X 1 point per second =

Time Penalty

Last obstacle completed prior to reaching the 8 (eight) minute mark: \_\_\_\_\_

Place an X on each course obstacle number that is completed in order:

|                          |                          |                          |                          |                          |                          |                          |                          |                          |                          |
|--------------------------|--------------------------|--------------------------|--------------------------|--------------------------|--------------------------|--------------------------|--------------------------|--------------------------|--------------------------|
| 1                        | 2                        | 3                        | 4                        | 5                        | 6                        | 7                        | 8                        | 9                        | 10                       |
| <input type="checkbox"/> | <input type="checkbox"/> | <input type="checkbox"/> | <input type="checkbox"/> | <input type="checkbox"/> | <input type="checkbox"/> | <input type="checkbox"/> | <input type="checkbox"/> | <input type="checkbox"/> | <input type="checkbox"/> |

JUDGE'S PRINTED NAME: \_\_\_\_\_ INITIALS: \_\_\_\_\_

## Smoothness of operation & Elapsed Time

- The on-board judge will determine if contestants make any sudden starts, stops or abrupt turns, and will indicate whether contestants wear their seat belts/shoulder harness while driving the course. The judge should be consistent in scoring all contestants.
- The timekeeper starts the clock when the vehicle is put into motion at the start line. The clock is stopped when the vehicle comes to a stop and is placed in a park at the right and left hand reverse exercises and the passenger stop, and started again when signaled to do so by the judges (by a slap on the side of the bus). The clock is stopped when the vehicle comes to a final stop at the judgment stop.
- One point will be deducted for each second more than 7 minutes required to complete the course.
- **Timekeepers are required to notify the contestants when they have reached the 7-minute mark** and instruct contestants that they have one minute remaining to complete the course.
- If the contestant is still on the course after 8 minutes, **the timekeeper will make a note as to the last completed exercise and no further points will accrue.** Points will be deducted by the scorekeepers for each obstacle incomplete. (Note: After the 7 minute mark no time will be announced and contestants will be permitted to complete the course.) Timekeepers must note the total elapsed time required to complete the course.
- If for any reason the bus must stop due to matters outside the control of the driver (obstruction on course, mechanical breakdown, or something similar) stop the clock and restart it once the driver is able to resume. This may occur due to a cone left in the path of the vehicle due to a previous contestant that must be reset, or your bus may be dragging a hit cone behind it. Judges will signal a stop by holding both hands towards the driver, palms outward.

## General Notes for Judges:

- Your responsibility extends from the start of the course to the completion of the final exercise, judgment stop.
- Make sure to record the driver # and vehicle # on every score sheet you hand in to the score runners.
- **The key to a fair course is that the same skill tests are the same for all operators.**
- Be careful that you do not unintentionally give the contestant's guidance through any means, including hand signals. You are not directing the contestants, you are scoring them. Keep your hand on the clipboard, or in your pockets! Similarly, spectators are not permitted to follow vehicles as they progress through the course.

# 12

## PRE-TRIP INSPECTION

CONTESTANT #

VEHICLE #:

This test will judge how thoroughly an operator checks his/her vehicle before taking it out on the road. There will be a vehicle at the Rodeo set up by Maintenance personnel with four known defects to identify.

### SCORING (150 Points Possible):

COURSE JUDGE

SCORE KEEPERS  
CALCULATIONS

### POINT DEDUCTIONS:

- |                                     |        |            |
|-------------------------------------|--------|------------|
| • Each Pre-set Item Missed          | _____X | 25 = _____ |
| • Inspection not completed          | _____X | 25 = _____ |
| • Inspection not logical/systematic | _____X | 25 = _____ |

**Total Points Deducted:**

**Total Points Earned:**

JUDGE'S PRINTED NAME: \_\_\_\_\_ INITIALS: \_\_\_\_\_

## **Pre-Trip Inspection Script**

1. There will be a 7-minute time limit on this exercise.
2. Total possible points: 150
3. Four (4) safety defects will be pre-set on the vehicle. These will be the same for all contestants. Drivers will receive twenty-five (25) points for each safety defect found. We realize that every transit system may have different pre-trip inspection checklists. As a result, all participants will have access to a standard pre-trip form.
4. Contestants must conduct their pre-trip inspections in a logical and systematic manner (i.e., moving from front of the vehicle to the back, left to right, or top to bottom). Drivers will earn twenty-five (25) points for doing so.
5. Drivers will earn another twenty-five (25) points for completing the inspection within the 7-minute time limit.
6. Safety defects may be found anywhere on the vehicle, including under the hood. (The hood will remain unlatched for each driver to access.)

## **During the Inspection**

Each contestant will conduct their inspection by verbalizing the item or area of inspection and then checking it. As contestants identify defects, they will describe that defect to the judge. The judge will write the defects described by the contestant on the contestant's Pre-Trip Inspection score sheet. Contestants may identify additional defects beyond the four preset on the vehicle, although they will only get credit for identifying the four preset defects. If a contestant has identified 4 or more defects and has not yet completed the full vehicle inspection, he/she must finish the inspection in order to earn twenty-five (25) points (subject to the seven minute time limit).

Upon request, judges can assist contestants with their inspections, though for specific tasks only. For instance, the judge may press the brake pedal, and shift the transmission into reverse with the ignition switch in the "on" position, but without the engine running. The judge can also assist the contestants in checking turn signals, brake and back-up lights, and turning on the lights and windshield wipers.

Once seven minutes are reached, inform the contestant that time has expired and cease marking their score. A contestant whose time expires before completion of the inspection will still get credit for a logical inspection process and for any of the four preset defects founds.

Contestants neither receive nor are penalized points for identifying any defects other than the four preset ones.

## **Contestants are not required, or allowed, to:**

1. Complete a full lift/engine interlock inspection or cycle the lift: Contestants are required to perform a visual inspection of the lift and its immediate surroundings.
2. Brake Inspection: Due to the time constraints of a Rodeo, the brake check will be limited to verifying that the service brake pedal is firm. Contestants will not be allowed to set the parking brake and attempt to move the vehicle.
3. Complete under the hood examination. Contestants are required to verbalize all areas under the hood that they would (if time was allotted) inspect and check.



## PRE TRIP INSPECTION FORM

VEH NO. \_\_\_\_\_ DATE \_\_\_\_\_

### INSPECT AND X OK or PROBLEM

Use Note to clarify Problem (i.e. left rear turn signal)

OK    Problem

#### UNDERHOOD

- Oil Level
- Coolant Level
- Windshield Washer Level
- Battery
- Hoses/Belts
- Coolant Leaks

Notes \_\_\_\_\_

#### EXTERIOR

- Tires/wheels
- Turn Signals
- Head Lights
- Tail/Brake Lights
- Marker Lights
- Windshield/Wipers
- Body Damage
- Mirrors
- Doors
- Cleanliness

#### INTERIOR

- Brakes & Parking Brake
- Steering
- Transmission
- Mirrors
- Gauges (incl. Fuel)
- Cleanliness
- Heater/AC
- Radio
- Horn
- Step-well & Dome lights
- Emergency Exit

#### SAFETY EQUIPMENT

- Accident Kit
- Fire Ext. Charged
- Flares/Triangle
- First Aid/Bloodborne Kit
- Back-Up Alarm
- Rear Door Buzzer
- Seat Belt Cutter

MILEAGE:    START \_\_\_\_\_  
                   END        \_\_\_\_\_  
                   TOTAL      \_\_\_\_\_

OK    Problem

#### WHEELCHAIR LIFT & SECUREMENT

- Cycle Lift
- Lift Mechanism
- Lift Belt & Safety plate
- Manual Pump Arm
- Shoulder/Lap Belts & Extensions
- Floor Securement Belts
- Transmission Interlock

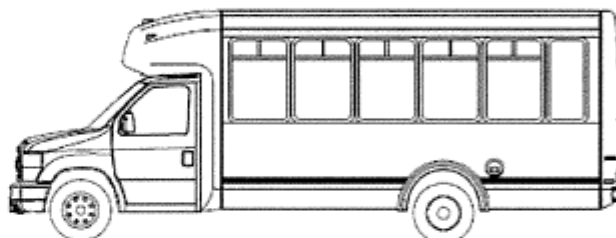

PLACE AN X TO INDICATE BODY DAMAGE

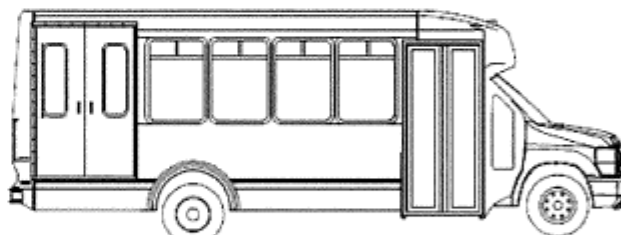

Driver Signature – Pre-Trip \_\_\_\_\_

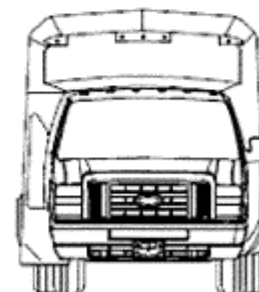
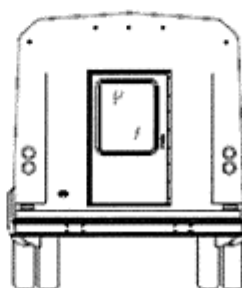

Maint. Spvr. Initials– Repairs Completed \_\_\_\_\_

In the event defects and malfunctions are discovered, drivers shall immediately notify the maintenance supervisor and dispatch staff before moving the vehicle.



# WHEELCHAIR LOADING & SECUREMENT - \*\*VERBAL\*\*

CONTESTANT #  
  
VEHICLE #:

Evaluate each contestant on his/her ability to load and secure a wheelchair user in the vehicle. The following criteria are to be employed in making each evaluation.

(Maximum Verbal Points – 90)

Vehicle Number \_\_\_\_\_

### A. Sensitivity & Awareness (Order not critical)

Circle

- \* Greets passenger..... 0 2
- \* Introduces self to passenger..... 0 2
- \* Asks passenger if they need assistance in boarding ..... 0 4
- \* Asks passenger if they have all their belongings..... 0 4
- \* States they are checking the securement of postural belt ..... 0 4
- \* States they are checking the hand grips on wheelchair ..... 0 4
- \* Asks passenger to place hands in lap ..... 0 8

Points from section A cannot be accumulated once section B has started.

A..... Actual points..... out of 28

### B. Loading Onto Platform

- \* States they are checking the rear safety plate ..... 0 4
- \* States they are backing the passenger onto platform..... 0 4
- \* States they are securing the wheelchair locks ..... 0 4
- \* States they are looking for lift belt..... 0 4

B..... Actual Points..... out of 16

### C. Raising Lift

- \* States that they are raising lift and checking front safety plate/barrier after it clears surface..... 0 4
- \* States that they are holding wheelchair with one hand while raising lift..... 0 4
- \* States that they are backing wheelchair into vehicle and securing at least one lock..... 0 4

**JUDGES NOTE – Do not allow passenger to remain on lift unattended.**

C..... Actual Points..... out of 12

### D. Wheelchair & Passenger Securement

- \* States that they are positioning wheelchair into securement location..... 0 4
- \* States that they are attaching front securement to the floor and wheelchair frame..... 0 6
- \* States that they are attaching back securement to the floor and wheelchair frame..... 0 6
- \* States that they are releasing wheel locks ..... 0 4
- \* States that they are reapplying wheelchair brakes ..... 0 2
- \* States that they are Securing lap belt at passenger’s hips and shoulder belt at the center of the chest .. 0 4
- \* States that they are placing lift in "stow" position ..... 0 8

D..... Actual Points..... out of 34

Add (A+B+C+D+E) \_\_\_\_\_

JUDGE’S PRINTED NAME: \_\_\_\_\_ INITIALS: \_\_\_\_\_

## Wheelchair Securement

1. The seven (7) minute time limit will be enforced. The 7 minutes does not include the time spent by the judge testing the wheelchair securement.
2. At the start of the Passenger Assistance exercise, the contestant will meet a passenger and judge. The contestant should approach the passenger as though the passenger were a person to be transported. The contestant must verbalize to the passenger all of the activities that he/she will perform in the process of loading and securing them in the vehicle. Contestants must say these activities loud enough for the judges to hear.
3. For example, the contestant must verbally ask the passenger if they have all of their belongings, not merely look around the area. The contestant must say that they are checking the handgrips on the wheelchair, and physically try to twist them. The contestant must say to the passenger that they are going to back them onto the lift. The contestant does not have to memorize a specific statement, but they must tell the passenger what they are going to do before they do it!
4. The passenger may be wearing a postural belt in the wheelchair. Before maneuvering the passenger on to the lift platform, the contestant must check the lap belt to verify that it is secure. The lifts should be equipped with rear safety plates. The contestant must physically check the rear safety plate to verify that it is engaged. Similarly, after the lift platform clears the ground, the contestant must physically check the front safety plate to verify that it is secure. Contestants will not be penalized for removing their hand from the wheelchair to check the front safety plate. For the purposes of this Rodeo, contestants will not be permitted to ride the lift platform. **Don't leave passenger on lift.**
5. After loading the passenger in the vehicle, the contestant must secure the wheelchair and passenger. After the contestant has positioned the wheelchair in the securement area, secured the front and rear tie downs, set the wheel locks and secured the lap belt/shoulder harness, time stops, and the driver will exit the vehicle. At this point, you have completed the exercise. The judge will release the wheel locks and attempt to roll the wheelchair and passenger forward and backward. If the wheelchair does not roll or slide in either direction, the contestant will receive 24 points. If the wheelchair rolls or slides by any amount, the contestant will receive zero (0) points for this portion of the exercise. Judges must be consistent in evaluating this portion of the exercise!
6. The judge or passenger will use a stop watch to record the elapsed time for this exercise, from the time that the contestant first greets them to the time that the contestant has completed securing the wheelchair. After seven minutes the exercise will be stopped and the contestant will be score based on their performance up to this point.
7. You will note on the score sheet that almost every item for this exercise indicates a point value for "verbal", and a point value for "performance". These are the points that the contestant receives for verbalizing what is being performed, and for the actual performance. If contestants do not verbalize what they are going to do before they do it, they do not receive the verbal point value. If they verbalize it, but they do not perform it, they do not receive the performance point value. Judges should circle point values on the score sheet as the contestants earns points, and total them at the end of the exercise.
8. The score sheet lists activities and their point values in a particular order. The items performed under "Sensitivity & Awareness" do not necessarily have to be performed in the exact order listed. However, the other activities do follow a logical order that must be followed. If contestants perform these activities out of order, they will not receive points for the activity that they skipped, or performed late. For example, if a contestant does not check the front safety plate until after he/she has backed the wheelchair into the vehicle, they would not receive 16 points for that item.
9. Drivers may not utilize a printed checklist or instruction sheet during this portion of the competition. Any drivers observed using such an aid will lose all possible points from this section, subject to the decision of the Course Marshal. Any permanent visual aids present on vehicles, equipment or facilities that are visible to all drivers may be referenced.



# WHEELCHAIR LOADING & SECUREMENT - \*\*PERFORM\*\*

CONTESTANT #  
VEHICLE #:

Evaluate each contestant on his/her ability to load and secure a wheelchair user in the vehicle. The following criteria are to be employed in making each evaluation.

(Maximum Points – 110 )

### A. Sensitivity & Awareness (Order not critical)

Circle

- \* Checks securement of postural belt ..... 0 4
- \* Checks hand grips on wheelchair..... 0 8

A..... Actual points..... out of 12

### B. Loading Onto Platform

- \* Checks rear safety plate ..... 0 12
- \* Backs passenger onto platform ..... 0 4
- \* Secures wheelchair locks ..... 0 4
- \* Looks for lift belt and secures, if present ..... 0 4

B..... Actual Points..... out of 24

### C. Raising Lift

- \* Raises lift and checks front safety plate/barrier after it clears surface ..... 0 12
- \* Holds wheelchair with one hand while raising lift ..... 0 4
- \* Secures lift control onto door or lift ..... 0 4
- \* Backs wheelchair into vehicle and secures at least one lock ..... 0 4

**JUDGES NOTE – Do not allow passenger to remain on lift unattended.**

C..... Actual Points..... out of 24

### D. Wheelchair & Passenger Securement

- \* Positions wheelchair into securement location facing forward and sets wheel locks ..... 0 4
- \* Attach front securement to the floor and wheelchair frame and tighten tiedowns ..... 0 6
- \* Attach back securement to the floor and wheelchair frame and tighten tiedowns..... 0 6
- \* Releases wheel locks in an attempt to gently roll wheelchair to insure no movement ..... 0 4
- \* Reapply wheelchair brakes. .... 0 2
- \* Secures lap belt at passenger’s hips and shoulder belt at the center of the chest ..... 0 4

D..... Actual Points..... out of 26

### E. Judge checks wheelchair to determine any movement (24 pts).....

- \* Determine movement (no more than 1 inch) ..... 0 12
- \* Front securement 3-8 inches apart at 45 degree angle outside of the front wheels ..... 0 6
- \* Rear securement between back wheels at 45 degree angle and attached to a stable location on frame.... 0 6

E...Actual Points out of 24

### F. Penalty for standing on lift (-25)

Add (A+B+C+D+E+F) \_\_\_\_\_

TOTAL TIME: \_\_\_\_\_  
(Time will be used as second tie breaker)

Total Points Earned \_\_\_\_\_

JUDGE’S PRINTED NAME: \_\_\_\_\_ INITIALS: \_\_\_\_\_

## Wheelchair Securement

1. The seven (7) minute time limit will be enforced. The 7 minutes does not include the time spent by the judge testing the wheelchair securement.
2. At the start of the Passenger Assistance exercise, the contestant will meet a passenger and judge. The contestant should approach the passenger as though the passenger were a person to be transported. The contestant must verbalize to the passenger all of the activities that he/she will perform in the process of loading and securing them in the vehicle. Contestants must say these activities loud enough for the judges to hear.
3. For example, the contestant must verbally ask the passenger if they have all of their belongings, not merely look around the area. The contestant must say that they are checking the handgrips on the wheelchair, and physically try to twist them. The contestant must say to the passenger that they are going to back them onto the lift. The contestant does not have to memorize a specific statement, but they must tell the passenger what they are going to do before they do it!
4. The passenger may be wearing a postural belt in the wheelchair. Before maneuvering the passenger on to the lift platform, the contestant must check the lap belt to verify that it is secure. The lifts should be equipped with rear safety plates. The contestant must physically check the rear safety plate to verify that it is engaged. Similarly, after the lift platform clears the ground, the contestant must physically check the front safety plate to verify that it is secure. Contestants will not be penalized for removing their hand from the wheelchair to check the front safety plate. For the purposes of this Roadeo, contestants will not be permitted to ride the lift platform. **Don't leave passenger on lift.**
5. After loading the passenger in the vehicle, the contestant must secure the wheelchair and passenger. After the contestant has positioned the wheelchair in the securement area, secured the front and rear tie downs, set the wheel locks and secured the lap belt/shoulder harness, time stops, and the driver will exit the vehicle. At this point, you have completed the exercise. The judge will release the wheel locks and attempt to roll the wheelchair and passenger forward and backward. If the wheelchair does not roll or slide in either direction, the contestant will receive 24 points. If the wheelchair rolls or slides by any amount, the contestant will receive zero (0) points for this portion of the exercise. Judges must be consistent in evaluating this portion of the exercise!
6. The judge or passenger will use a stop watch to record the elapsed time for this exercise, from the time that the contestant first greets them to the time that the contestant has completed securing the wheelchair. After seven minutes the exercise will be stopped and the contestant will be score based on their performance up to this point.
7. You will note on the score sheet that almost every item for this exercise indicates a point value for "verbal", and a point value for "performance". These are the points that the contestant receives for verbalizing what is being performed, and for the actual performance. If contestants do not verbalize what they are going to do before they do it, they do not receive the verbal point value. If they verbalize it, but they do not perform it, they do not receive the performance point value. Judges should circle point values on the score sheet as the contestants earns points, and total them at the end of the exercise.
8. The score sheet lists activities and their point values in a particular order. The items performed under "Sensitivity & Awareness" do not necessarily have to be performed in the exact order listed. However, the other activities do follow a logical order that must be followed. If contestants perform these activities out of order, they will not receive points for the activity that they skipped, or performed late. For example, if a contestant does not check the front safety plate until after he/she has backed the wheelchair into the vehicle, they would not receive 16 points for that item.
9. Drivers may not utilize a printed checklist or instruction sheet during this portion of the competition. Any drivers observed using such an aid will lose all possible points from this section, subject to the decision of the Course Marshal. Any permanent visual aids present on vehicles, equipment or facilities that are visible to all drivers may be referenced.

2024 TAM ROADEO COURSE

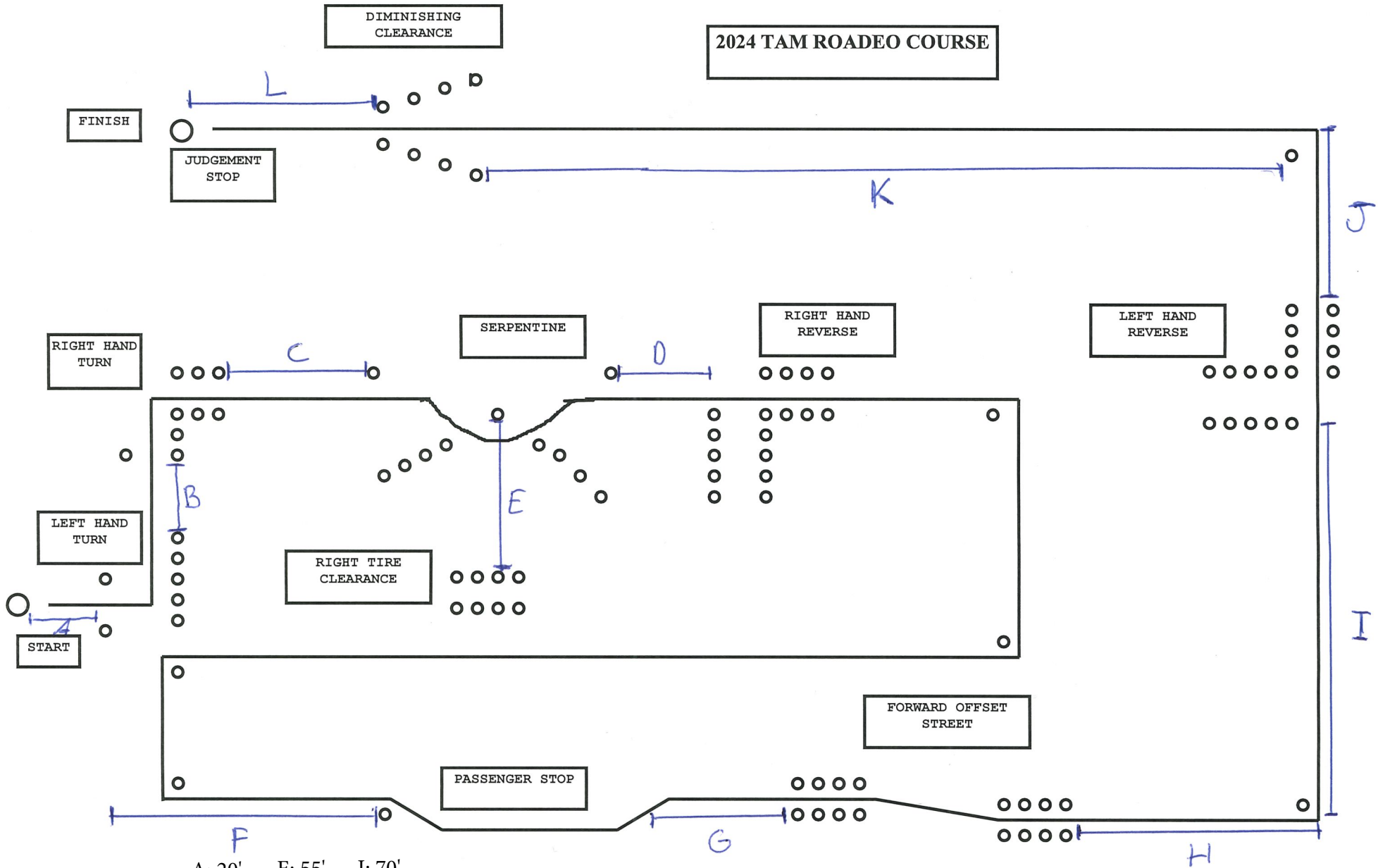

Distances between obstacles:

- |        |         |         |
|--------|---------|---------|
| A: 20' | E: 55'  | I: 70'  |
| B: 75' | F: 110' | J: 55'  |
| C: 50' | G: 70'  | K: 150' |
| D: 40' | H: 65'  | L: 65'  |